

# ATRIA XS R

## SPECIFICATIONS



base code	66096
typology	Glare free downlight with recessed trim and symmetrical or wallwasher light distribution
mounting	In plasterboard using springs (included)
diameter	78 mm / 3.1"
height	Downlight: 105 mm / 4.2". Wallwasher downlight: 78 mm / 3.1"
required depth	Downlight: 120 mm / 4.7". Wallwasher downlight: 100 mm / 3.9"
ceiling cut out	67 mm / 2.64"
construction	Fixture and flange: turning and milling aluminum. Reflector: polycarbonate. Protective glass in PMMA or softening glass complete with silicone gasket
finishes	Powder coated. Heat sink anodized
ingress protection	IP30, IP44 or IP66. North America: dry, damp or wet location
lamp type	COB. Remote power supply not included
lamp wattage	10W at 24V DC and 500mA. For Yacht operating voltage 20V-30V. <b>Vf 17,8V DC.</b> Tunable white: max 10W at 500 mA (CH1 + CH2 max 10W, one channel max 10W). <b>Vf 17,8V DC.</b> Dim to warm: 10W at 280 mA. <b>Vf 34V DC</b>
delivered lumens	IP30: 850lm (30°) - 930lm (50°) - 970lm (70°) - 790lm (wallwasher) IP44 / IP66: 760lm (30°) - 840lm (50°) - 870lm (70°) - 710lm (wallwasher)
lumen maintenance	50.000h L90
beam	30°, 50°, 70° or <b>wallwasher (downlight 25° and wallwasher)</b>
kelvin	2700K CRI93, 3000K CRI93, 4000K CRI93 / 3 step MacAdam ellipse, tunable white 1800K - 4000K CRI93, or dim to warm 1800K - 3000K CRI93
special features	Safe Wiring Two Wires Dimming. Designed to deliver glare free homogeneous light. UGR<10 (30°), UGR<19 (50°), UGR<25 (70°). The wallwasher offers longitudinal cut-off and delivers homogeneous light from the upper edge of the wall to the floor with no visible dark zones
control protocols	0-10V, DMX or DALI
certifications	CE, ETL listed (certified to UL 2108, CSA C22.2)



30°, 50°, 70° BEAM



WALLWASHER



30°, 50°, 70° BEAM

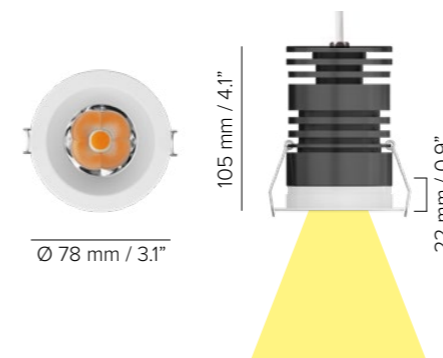

WALLWASHER

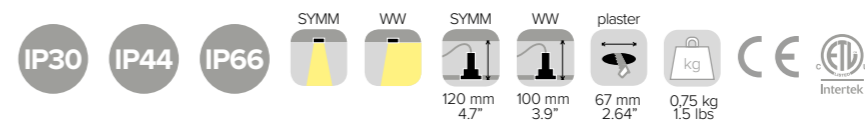
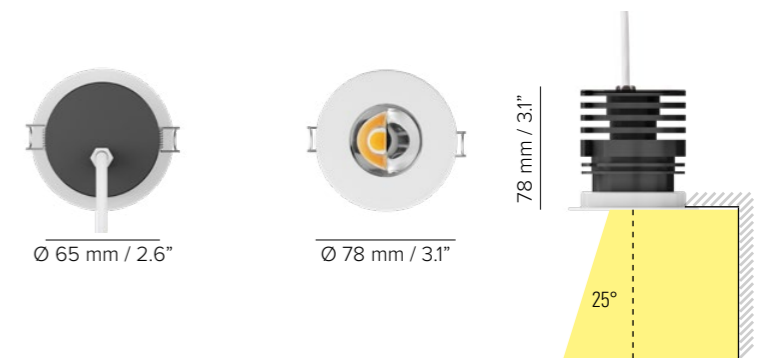

# ATRIA XS R

## INSTALLATION GUIDE FOR WALLWASHER

FOR A GOOD UNIFORMITY OF LIGHT ON THE WALL, FOLLOW THESE RULES:

1

The **distance from the wall D** shall be minimum  $H / 5$  and maximum  $H / 3$

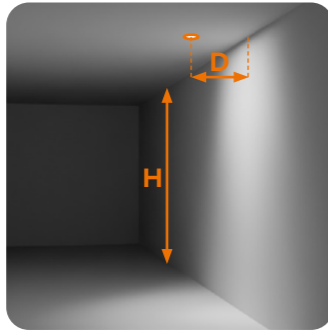

2

The **spacing between luminaires S** shall be minimum the distance **D** from the wall and maximum twice the distance **D x 2** from the wall

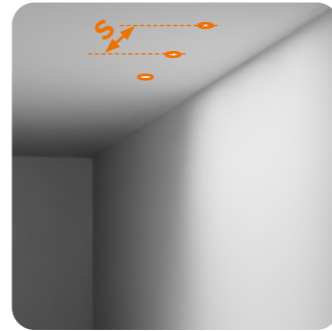

**ATRIA XS R**  
10W, 790lm delivered

H 3 m 9' 10"	D <sub>MIN</sub> 0,6 m 1' 11"	S <sub>MIN</sub> 0,6 m 1' 11"
		S <sub>MAX</sub> 1,2 m 3' 11"
	D <sub>MAX</sub> 1 m 3' 3"	S <sub>MIN</sub> 1 m 3' 3"
		S <sub>MAX</sub> 2 m 6' 7"



- 20lx
- 50lx
- 100lx
- 200lx

# WALLWASHER OPTIONS

FOR DIFFERENT CEILING HEIGHTS



**ATRIA X3 R**  
30W, 2440lm delivered

SEE PAGE 473



**INSIDE 120 R**  
30W, 2440lm delivered

SEE PAGE 401



**ATRIA X3 R**  
23W, 2025lm delivered

SEE PAGE 473



**INSIDE 120 R**  
23W, 2025lm delivered

SEE PAGE 401

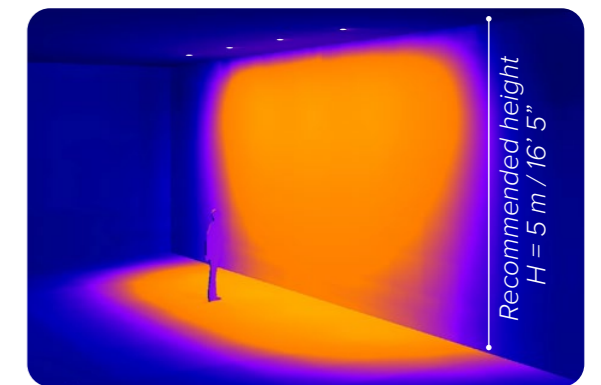

**ATRIA 60 P**  
6W, 570lm delivered

SEE PAGE 79



**INSIDE 60 R**  
6W, 570lm delivered

SEE PAGE 381

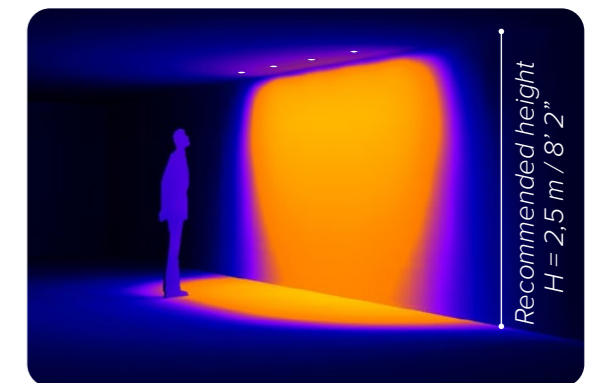

**DOT 45**  
4W, 220lm delivered

SEE PAGE 437



**INSIDE 40 R**  
4W, 220lm delivered

SEE PAGE 373

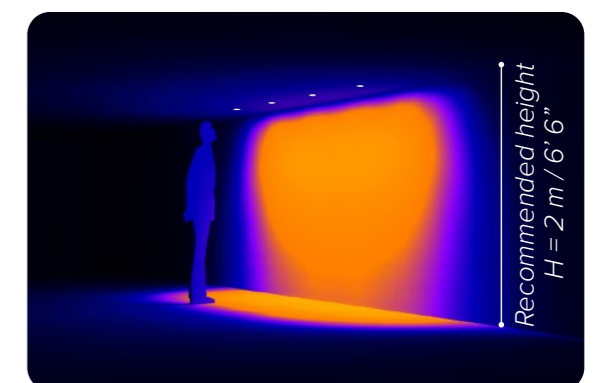

- 20lx
- 50lx
- 100lx
- 200lx

Since every project is different, use this installation guide as a starting point for your lighting design. To further test the desired effect on your project, use the **photometric files** available on B LIGHT's website.

# ATRIA XS R

## ACCESSORIES

### BASE CODE

66096

### A . POWER SUPPLY

**2** 24V DC (20V - 30V)  
FOR YACHT ONLY  
power supply  
NOT included

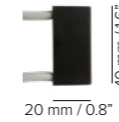

**L** 500 mA  
power supply  
NOT included

**U** listed  
500 mA  
power supply  
NOT included

### B . KELVIN

**4** 4000K CRI93

**5** 3000K CRI93

**8** 2700K CRI93

**7** tunable white  
1800K - 4000K CRI93

**H** dim to warm  
1800K - 3000K CRI93  
*ONLY WITH SOFTENING  
GLASS AND IP44*

### C . BEAM

**4** spot 30°

**F** spot 30°,  
softening glass

**5** flood 50°

**G** flood 50°,  
softening glass

**8** wide flood 70°

**H** wide flood 70°,  
softening glass

**A** chrome  
wallwasher

**C** black  
wallwasher

BASE CODE

Example: **66096** **A** **B** **C** **D** **E** = **66096-28A6C**

### D . FINISHES

**2** black  
RAL 9005



**6** white  
RAL 9003



### E . INGRESS PROTECTION

**A** IP30

**B** IP44

**C** IP66

### WALLWASHER BEAM

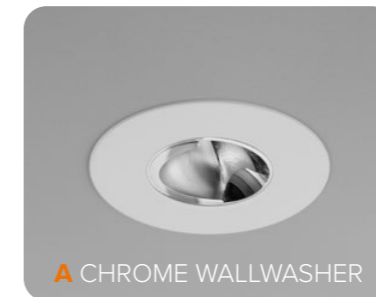

WALLWASHER

# ATRIA XS R

## ACCESSORIES

### REQUIRED ACCESSORIES - NOT INCLUDED

	code	output power	input voltage	frequency	IP	dimensions mm	through cut out
Power supply 500 mA max No. fixtures	69109	ON/OFF, 10W / max 1	198-264V	50-60Hz	IP20	L100xW43XH23	YES
	69091	1-10V, 20W / max 2	99-264V	50-60Hz	IP20	L120xW52XH22	YES
	69080	DALI, 20W / max 2	220-240V	50-60Hz	IP20	L120xW52xH22	YES
	69206	DALI, 24W / max 2	99-264V	50-60Hz	IP67	L122xW54xH26	YES
Power supply tunable white 500 mA max No. fixtures	69119	DALI DT8, 25W / max 2	198-264V	50-60Hz	IP20	L123xW79XH30	NO
Power supply dim to warm 280 mA max No. fixtures	69222	1-10V, 15W / max 1	99-264V	50-60Hz	IP20	L111xW52XH22	YES
	69223	DALI, 10W / max 1	220-240V	50-60Hz	IP20	Ø39xH21	YES
Class 2 power supply 500 mA UL listed	Consult <b>B LIGHT North America</b> Lighting Group Network T: 212.775.6363 E: info@lightinggroupnetwork.com						

Power supply selection		
DC MIN Output (V)	LED Output (Vf) < <b>17,8V DC</b>	DC MAX Output (V)



WALLWASHER