

ATRIA X3 R

SPECIFICATIONS

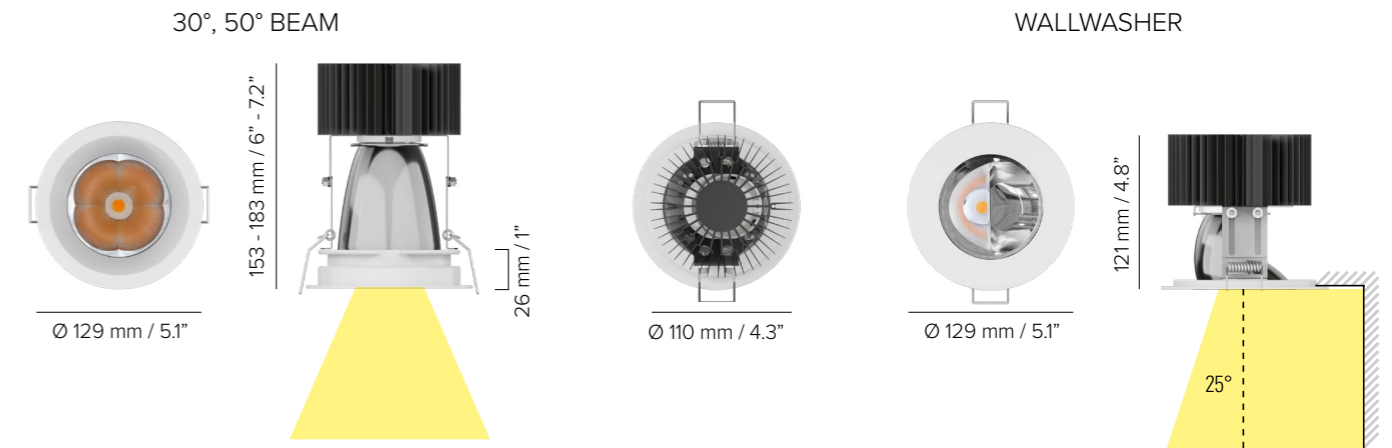

base code	64140
typology	Glare free downlight with recessed trim and symmetrical or wallwasher
mounting	In plasterboard using springs (included)
diameter	129 mm / 5.1"
height	Symmetrical 30°: 183 mm / 7.2". Symmetrical 50°: 153 mm / 6". Wallwasher: 121 mm / 4.8"
required depth	Symmetrical 30°: 190 mm / 7.5". Symmetrical 50°: 160 mm / 6.3". Wallwasher: 130 mm / 5.1"
ceiling cut out	120 mm / 4.72"
construction	Fixture and flange: turning and milling aluminum. Extruded aluminum heat sink. Reflector: polycarbonate
finishes	Powder coated. Heat sink anodized
ingress protection	IP20. North America: dry location
lamp type	COB. Remote power supply not included
lamp wattage	23W at 700 mA, 30W at 900 mA. Tunable white: maximum wattage 30W (CH1 + CH2 max 30W, one channel max 30W)
delivered lumens	23W: 1775lm (30°) - 1760lm (50°) - 2025lm (wallwasher) 30W: 2145lm (30°) - 2190lm (50°) - 2440lm (wallwasher)
lumen maintenance	50.000h L90
beam	30°, 50° or wallwasher (downlight 25° and wallwasher)
kelvin	2700K CRI93, 3000K CRI93 and 4000K CRI93 / 3 step MacAdam ellipse or tunable white 1800K - 4000K CRI93
special features	Safe Wiring. Two Wires Dimming. Designed with symmetrical and wallwasher reflectors, delivers glare free homogeneous light. UGR<10 (30°), UGR<19 (50°). The wallwasher offers longitudinal cut-off and delivers homogeneous light from the upper edge of the wall to the floor with no visible dark zones
control protocols	0-10V, DMX or DALI
certifications	CE, ETL listed (certified to UL 2108, CSA C22.2)



IP20

SYMM WW 30° 50° WW plasterboard

190 mm / 7.5" 160 mm / 6.3" 130 mm / 5.1" 120 mm / 4.72"

0.8 kg / 1.8 lbs

CE ETL Intertek

ATRIA X3 R

INSTALLATION GUIDE FOR WALLWASHER

FOR A GOOD UNIFORMITY OF LIGHT ON THE WALL, FOLLOW THESE RULES:

1

The **distance from the wall D** shall be minimum $H / 5$ and maximum $H / 3$

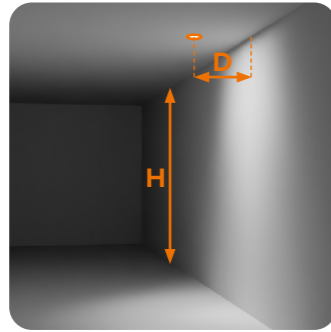

2

The **spacing between luminaires S** shall be minimum the distance **D** from the wall and maximum twice the distance **D x 2** from the wall



ATRIA X3 R at 700mA 23W, 2025lm delivered

H 5 m 16' 5"	D _{MIN} 1 m 3' 3"	S _{MIN} 1 m 3' 3"
		S _{MAX} 2 m 6' 7"
	D _{MAX} 1,6 m 5' 3"	S _{MIN} 1,6 m 5' 3"
		S _{MAX} 3,2 m 10' 6"

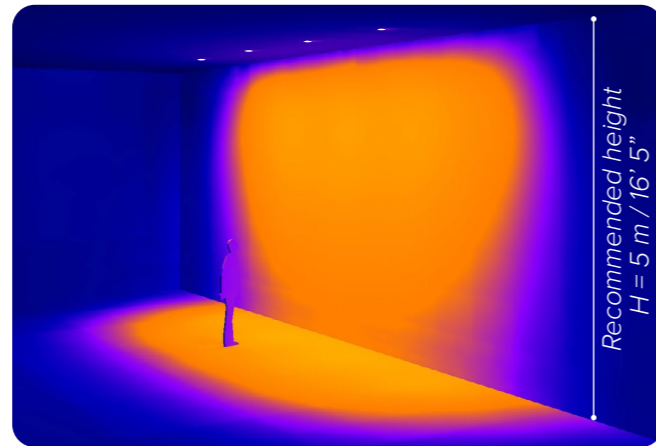

ATRIA X3 R at 900mA 30W, 2440lm delivered

H 7 m 22' 12"	D _{MIN} 1,4 m 4' 7"	S _{MIN} 1,4 m 4' 7"
		S _{MAX} 2,8 m 9' 2"
	D _{MAX} 2,3 m 7' 7"	S _{MIN} 2,3 m 7' 7"
		S _{MAX} 4,6 m 15' 1"

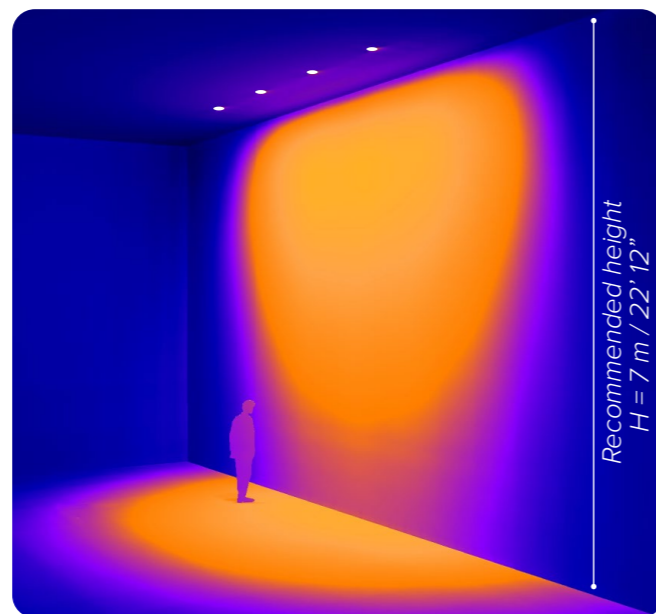

20lx 50lx 100lx 200lx

WALLWASHER OPTIONS

FOR DIFFERENT CEILING HEIGHTS



ATRIA XS R
10W, 790lm delivered

SEE PAGE 451



INSIDE 75 R
10W, 790lm delivered

SEE PAGE 387



ATRIA 60 P
6W, 570lm delivered

SEE PAGE 445



INSIDE 60 R
6W, 570lm delivered

SEE PAGE 381



DOT 45
4W, 220lm delivered

SEE PAGE 437



INSIDE 40 R
4W, 220lm delivered

SEE PAGE 373

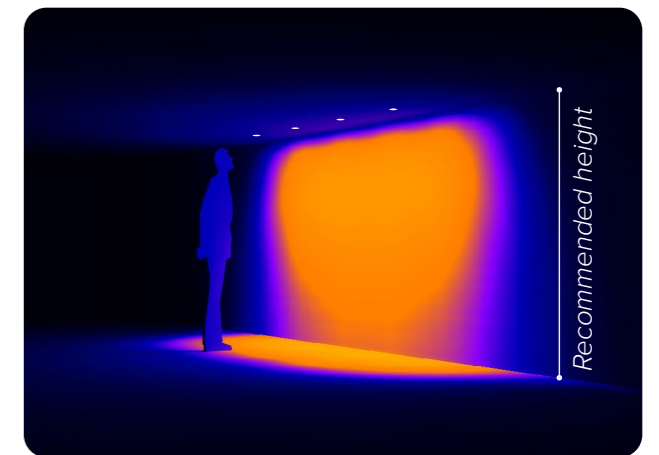
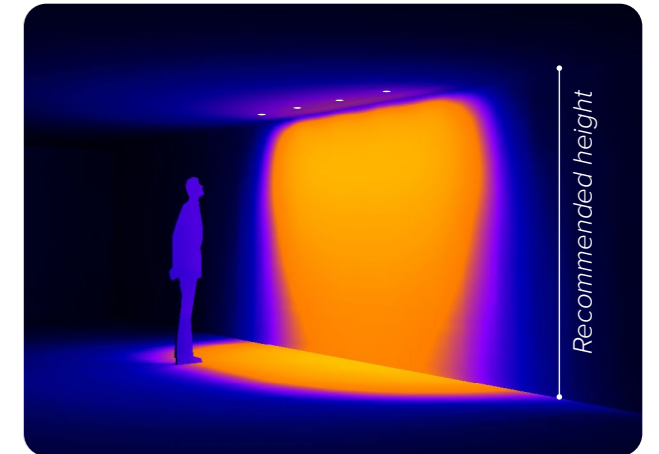
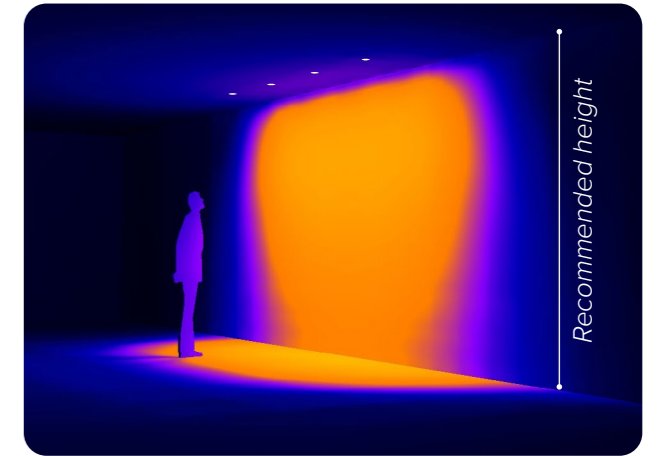

20lx 50lx 100lx 200lx

Since every project is different, use this installation guide as a starting point for your lighting design. To further test the desired effect on your project, use the **photometric files** available on B LIGHT's website.

ATRIA X3 R

ORDER CODE

BASE CODE

64140





A . POWER SUPPLY

- L** 700/900 mA power supply NOT included
- U**  listed 700/900 mA power supply NOT included

B . KELVIN

- 4** 4000K CRI93
- 5** 3000K CRI93
- 8** 2700K CRI93
- 7** tunable white 1800K - 4000K CRI93

C . BEAM

- 4** spot 30° 
- 5** flood 50° 
- A** chrome wallwasher 
- C** black wallwasher 

Example: BASE CODE **64140** A B C D
L 5 A 6 = **64140-L5A6**

D . FINISHES

- 2** black RAL 9005 
- 6** white RAL 9003 

ACCESSORIES

REQUIRED ACCESSORIES - NOT INCLUDED

	code	output power	input voltage	frequency	IP	dimensions mm	through cut out
23W output Power supply 700 mA max No. fixtures	69089	ON/OFF, 25W / max 1	176-264V	50-60Hz	IP20	L135xW38xH28	YES
	69092	1-10V, 25W / max 1	99-264V	50-60Hz	IP20	L103xW67xH21	YES
	69074	DALI, 32W / max 1	110-240V	50-60Hz	IP20	L103xW67xH21	YES
Power supply tunable white 700 mA max No. fixtures	69131	DALI DT8, 35W / max 1	198-264V	50-60Hz	IP20	L123xW79xH30	YES
30W output Power supply 900 mA max No. fixtures	69094	ON/OFF, 38W / max 1	176-264V	50-60Hz	IP20	L130xW42xH30	YES
	69093	1-10V, 50W / max 1	99-264V	50-60Hz	IP20	L129xW76xH30	YES
	69077	DALI, 60W / max 2	99-264V	50-60Hz	IP20	L129xW76xH30	YES
Power supply tunable white 900 mA max No. fixtures	69132	DALI DT8, 45W / max 1	198-264V	50-60Hz	IP20	L123xW79xH30	YES
Class 2 power supply 700 mA 900 mA  listed	Consult B LIGHT North America Lighting Group Network T: 212.775.6363 E: info@lightinggroupnetwork.com						

WALLWASHER